

Thrust Ball Bearings

Thrust ball bearings are separable bearings, including a shaft washer (to match with the shaft), a seat washer (to match with the bearing housing), and a ball & cage assembly.

There are two types of thrust ball bearings: Single-direction thrust ball bearing and bi-directional thrust ball bearing.

Single-direction thrust ball bearing can only bear axial load from one direction, and can be used for axial positioning in single direction.

Bi-directional thrust ball bearing can bear axial loads from two directions, and can be used for axial positioning in two directions.



Thrust ball bearings are generally available with pressed steel cage. Machined steel cage or brass cage are also possible.

d: 10 ~ 50 mm

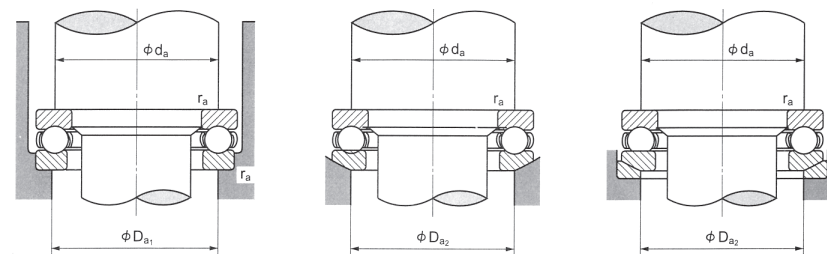
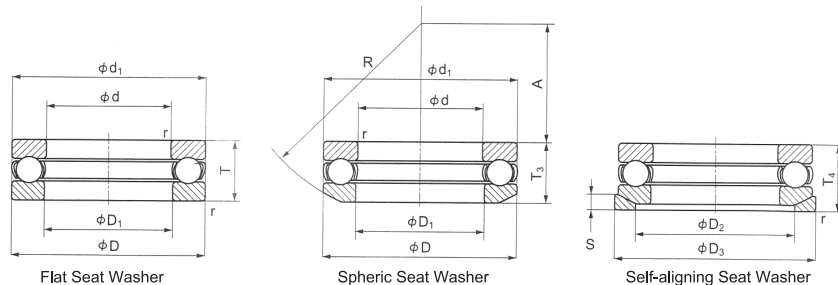

Principal Dimensions (mm)						Bearing Designations			Basic Load Ratings (N)		Limiting Speed (rpm)		Bearing Designations										Abutment and Fillet Dimensions			Weight (kg)		
d	D	T	T ₃	T ₄	r (min)	Flat Seat Washer	Spheric Seat Washer	Self-Aligning Seat Washer	Dynamic C _a	Static C _{0a}	Grease	Oil	D ₁ (min)	d ₁ (max)	D ₂	D ₃	S	R	A	d _a (min)	D _{a1} (max)	D _{a2} (max)	r _a (max)	Flat Seat Washer	Spheric Seat Washer	Self-Aligning Seat Washer		
10	24	9			0.3	51100			10000	14000	6800	10000	11	24						18	16		0.3	0.020				
	26	11	11.6	13	0.6	51200	53200	53200U	12700	17100	5900	8800	12	26	18	28	3.5	22	8.5	20	16	18	0.6	0.030	0.029	0.036		
12	26	9			0.3	51101			10300	15400	6500	9800	13	26						20	18		0.3	0.022				
	28	11	11.4	13	0.6	51201	53201	53201U	13200	19000	5600	8500	14	28	20	30	3.5	25	11.5	22	18	20	0.6	0.034	0.033	0.041		
15	28	9			0.3	51102			10500	16800	6200	9400	16	28						23	20		0.3	0.024				
	32	12	13.3	15	0.6	51202	53202	53202U	16600	24800	5100	7600	17	32	24	35	4	28	12	25	22	24	0.6	0.046	0.048	0.061		
17	30	9			0.3	51103			10800	18200	6000	9100	18	30						25	22		0.3	0.028				
	35	12	13.2	15	0.6	51203	53203	53203U	17100	27300	4800	7300	19	35	26	38	4	32	16	28	24	26	0.6	0.053	0.055	0.070		
20	35	10			0.3	51104			14300	24700	5300	8000	21	35						29	26		0.3	0.040				
	40	14	14.7	17	0.6	51204	53204	53204U	22200	27500	4200	6300	22	40	30	42	5	36	18	32	28	30	0.6	0.082	0.080	0.100		
25	42	11			0.6	51105			19500	37000	4600	6900	26	42						35	32		0.6	0.059				
	47	15	16.7	19	0.6	51205	53205	53205U	27800	50500	3700	5600	27	47	36	50	5.5	40	19	38	34	36	0.6	0.120	0.125	0.160		
	52	18	19.8	22	1	51305	53305	53305U	35500	61500	3200	4900	27	52	38	55	6	45	21	41	36	38	1	0.180	0.185	0.225		
	60	24	26.4	29	1	51405	53405	53405U	55500	89500	2600	3900	27	60	42	62	8	50	19	46	39	42	1	0.340	0.350	0.420		
30	47	11			0.6	51106			20400	42000	4300	6500	32	47						40	37		0.6	0.068				
	52	16	17.8	20	0.6	51206	53206	53206U	29300	58000	3400	5200	32	52	42	55	5.5	45	22	43	39	42	0.6	0.150	0.160	0.195		
	60	21	22.6	25	1	51306	53306	53306U	42500	78500	2800	4200	32	60	45	62	7	50	22	48	42	45	1	0.270	0.270	0.325		
	70	28	30.1	33	1	51406	53406	53406U	72500	126000	2200	3300	32	70	50	75	9	56	20	54	46	50	1	0.530	0.530	0.680		
35	52	12			0.6	51107			20400	44500	4000	6000	37	52						45	42		0.6	0.085				
	62	18	19.9	22	1	51207	53207	53207U	39000	78000	2900	4400	37	62	48	65	7	50	24	51	46	48	1	0.220	0.220	0.290		
	68	24	25.6	28	1	51307	53307	53307U	55500	105000	2400	3700	37	68	52	72	7.5	56	24	55	48	52	1	0.390	0.390	0.475		
	80	32	34	37	1.1	51407	53407	53407U	87000	155000	1900	2900	37	80	58	85	10	64	23	62	53	58	1	0.790	0.790	0.950		
40	60	13			0.6	51108			26900	63000	3500	5300	42	60						52	48		0.6	0.120				
	68	19	20.3	23	1	51208	53208	53208U	47000	98500	2700	4100	42	68	55	72	7	56	28.5	57	51	55	1	0.270	0.270	0.340		
	78	26	28.5	31	1	51308	53308	53308U	69000	135000	2200	3300	42	78	60	82	8.5	64	28	63	55	60	1	0.550	0.570	0.690		
	90	36	38.2	42	1.1	51408	53408	53408U	112000	205000	1700	2600	42	90	65	95	12	72	26	70	60	65	1	1.14	1.13	1.38		
45	65	14			0.6	51109			27800	69000	3300	4900	47	65						57	53		0.6	0.150				
	73	20	21.3	24	1	51209	53209	53209U	47500	105000	2600	3900	47	73	60	78	7.5	56	26	62	56	60	1	0.320	0.320	0.410		
	85	28	30.1	33	1	51309	53309	53309U	80000	163000	2000	3000	47	85	65	90	10	64	25	69	61	65	1	0.690	0.680	0.850		
	100	39	42.4	46	1.1	51409	53409	53409U	129000	243000	1600	2400	47	100	72	105	12.5	80	29	78	67	72	1	1.47	1.50	1.80		
50	70	14			0.6	51110			28800	75500	3100	4700	52	70						62	58		0.6	0.160				
	78	22	23.5	26	1	51210	53210	53210U	48500	112000	2400	3600	52	78	62	82	7.5	64	32.5	67	61	62	1	0.390	0.380	0.480		
	95	31	34.3	37	1.1	51310	53310	53310U	96500	202000	1800	2700	52	95	72	100	11	72	28	77	68	72	1	1.00	1.00	1.25		
	110	43	45.6	50	1.5	51410	53410	53410U	148000	283000	1400	2100	52	110	80	115	14	90	35	86	74	80	1.5	1.99	1.97	2.40		



d: 55 ~ 100 mm

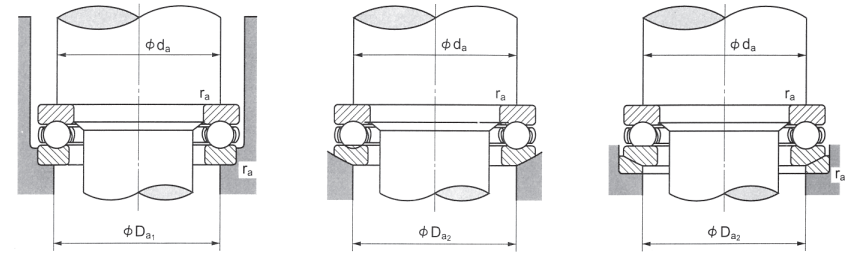
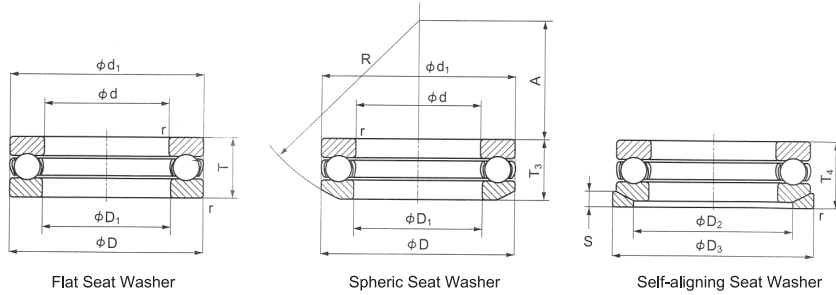

Principal Dimensions (mm)							Bearing Designations			Basic Load Ratings (N)		Limiting Speed (rpm)		Bearing Designations										Abutment and Fillet Dimensions			Weight (kg)		
d	D	T	T ₃	T ₄	r (min)	Flat Seat Washer	Spheric Seat Washer	Self-Aligning Seat Washer	Dynamic C _a	Static C _{0a}	Grease	Oil	D ₁ (min)	d ₁ (max)	D ₂	D ₃	S	R	A	d _a (min)	D _{a1} (max)	D _{a2} (max)	r _a (max)	Flat Seat Washer	Spheric Seat Washer	Self-Aligning Seat Washer			
55	78	16			0.6	51111			35000	93000	2800	4200	57	78						69	64		0.6	0.240					
	90	25	27.3	30	1	51211	53211	53211U	69500	159000	2100	3100	57	90	72	95	9	72	35	76	69	72	1	0.610	0.620	0.800			
	105	35	39.3	42	1.1	51311	53311	53311U	120000	246000	1600	2400	57	105	80	110	11.5	80	30	85	75	80	1	1.34	1.40	1.70			
	120	48	50.5	55	1.5	51411	53411	53411U	178000	360000	1300	1900	57	120	88	125	15.5	90	28	94	81	88	1.5	2.64	2.55	3.70			
60	85	17			1	51112			41500	113000	2600	3900	62	85						75	70		1	0.290					
	95	26	28	31	1	51212	53212	53212U	73500	179000	2000	3000	62	95	78	100	9	72	32.5	81	74	78	1	0.690	0.690	0.850			
	110	35	38.3	42	1.1	51312	53312	53312U	123000	267000	1600	2400	62	110	85	115	11.5	90	41	90	80	85	1	1.43	1.45	1.75			
	130	51	54	58	1.5	51412	53412	53412U	213000	435000	1200	1800	62	130	95	135	16	100	34	102	88	95	1.5	3.30	3.25	3.85			
65	90	18			1	51113			41500	117000	2400	3700	67	90						80	75		1	0.340					
	100	27	28.7	32	1	51213	53213	53213U	75000	189000	1900	2800	67	100	82	105	9	80	40	86	79	82	1	0.770	0.770	0.940			
	115	36	39.4	43	1.1	51313	53313	53313U	127000	287000	1500	2300	67	115	90	120	12.5	90	38.5	95	85	90	1	1.57	1.60	1.95			
	140	56	60.2	65	2	51413	53413	53413U	231000	495000	1100	1600	68	140	100	145	17.5	112	40	110	95	100	2	4.18	4.17	4.95			
70	95	18			1	51114			43000	127000	2400	3600	72	95						85	80		1	0.360					
	105	27	28.8	32	1	51214	53214	53214U	76000	199000	1800	2800	72	105	88	110	9	80	38	91	84	88	1	0.810	0.800	0.980			
	125	40	44.2	48	1.1	51314	53314	53314U	148000	340000	1400	2100	72	125	98	130	13	100	43	103	92	98	1	2.06	2.15	2.55			
	150	60	63.6	69	2	51414	53414	53414U	250000	555000	1000	1500	73	150	110	155	19.5	112	34	118	102	110	2	5.11	4.94	5.93			
75	100	19			1	51115			44500	136000	2200	3400	77	100						90	85		1	0.420					
	110	27	28.3	32	1	51215	53215	53215U	77500	209000	1800	2700	77	110	92	115	9.5	90	49	96	89	92	1	0.860	0.840	1.05			
	135	44	48.1	52	1.5	51315	53315	53315U	170000	395000	1200	1900	77	135	105	140	15	100	37	111	99	105	1.5	2.68	2.70	3.25			
	160	65	69	75	2	51415	53415	53415U	252000	560000	950	1400	78	160	115	165	21	125	42	126	109	115	2	6.35	6.25	7.60			
80	105	19			1	51116			44500	141000	2200	3300	82	105						95	90		1	0.430					
	115	28	29.5	33	1	51216	53216	53216U	78500	219000	1700	2600	82	115	98	120	10	90	46	101	94	98	1	0.950	0.930	1.16			
	140	44	47.6	52	1.5	51316	53316	53316U	176000	425000	1200	1800	82	140	110	145	45	112	50	116	104	110	1.5	2.82	2.85	3.45			
	170	68	72.2	78	2.1	51416	53416	53416U	270000	620000	900	1300	83	170	125	175	22	125	36	134	116	125	2	7.97	7.83	9.14			
85	110	19			1	51117			46000	150000	2100	3200	87	110						100	95		1	0.460					
	125	31	33.1	37	1	51217	53217	53217U	95500	264000	1600	2400	88	125	105	130	11	100	52	109	101	105	1	1.29	1.29	1.60			
	150	49	53.4	58	1.5	51317	53317	53317U	206000	490000	1100	1700	88	150	115	155	17.5	112	43	124	111	115	1.5	3.66	3.65	4.45			
	180	72	77	83	2.1	51417	53417	53417U	288000	685000	850	1200	88	177	130	185	23	140	47	142	123	130	2	9.30	9.20	10.9			
90	120	22			1	51118			59500	190000	1900	2900	92	120						108	102		1	0.680					
	135	35	38.5	42	1.1	51218	53218	53218U	116000	325000	1400	2100	93	135	110	140	13.5	100	45	117	108	110	1	1.77	1.78	2.22			
	155	50	54.6	59	1.5	51318	53318	53318U	213000	525000	1100	1600	93	155	120	160	18	112	40	129	116	120	1.5	3.88	3.84	4.70			
	190	77	81.2	88	2.1	51418	53418	53418U	305000	750000	790	1100	93	187	140	195	25.5	140	40	150	130	140	2	11.0	10.7	12.6			
100	135	25			1	51120			85000	268000	1700	2500	102	135						121	114		1	0.990					
	150	38	40.9	45	1.1	51220	53220	53220U	146000	410000	1300	1900	103	150	125	155	14	112	52	130	120	125	1	2.36	2.36	2.87			
	170	55	59.2	64	1.5	51320	53320	53320U	236000	595000	1000	1500	103	170	135	175	18	125	46	142	128	135	1.5	5.11	5.12	6.10			
	210	85	90	98	3	51420	53420	53420U	345000	895000	710	1000	103	205	155	220	27	160	50	166	144	155	2.5	14.7	14.5	17.2			



d: 110 ~ 180 mm

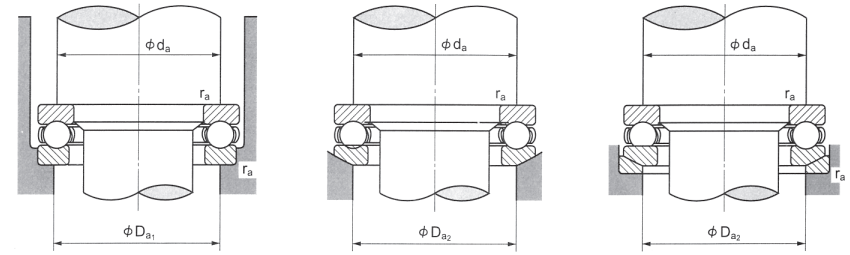
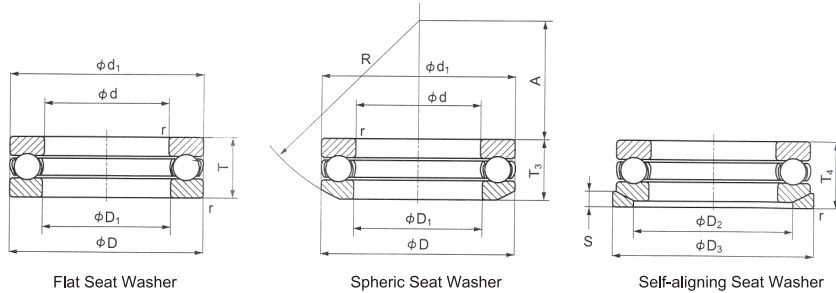

Principal Dimensions (mm)							Bearing Designations			Basic Load Ratings (N)		Limiting Speed (rpm)		Bearing Designations										Abutment and Fillet Dimensions			Weight (kg)		
d	D	T	T ₃	T ₄	r (min)	Flat Seat Washer	Spheric Seat Washer	Self-Aligning Seat Washer	Dynamic C _a	Static C _{0a}	Grease	Oil	D ₁ (min)	d ₁ (max)	D ₂	D ₃	S	R	A	d _a (min)	D _{a1} (max)	D _{a2} (max)	r _a (max)	Flat Seat Washer	Spheric Seat Washer	Self-Aligning Seat Washer			
110	145	25			1	51122			87000	288000	1600	2400	112	145							131	124		1	1.08				
	160	38	40.2	45	1.1	51222	53222	53222U	152000	450000	1200	1900	113	160	135	165	14	125	65	140	130	135	1	2.57	2.53	3.00			
	190	63	67.2	72	2	51322	53322	53322U	267000	705000	880	1300	113	187	150	195	20.5	140	51	158	142	150	2	7.73	7.66	8.96			
	230	95	99.7	109	3	51422	53422	53422U	435000	1240000	640	960	113	225	170	240	29	180	59	182	158	170	2.5	19.8	19.4	22.9			
120	155	25			1	51124			89000	305000	1600	2400	122	155							141	134		1	1.16				
	170	39	40.8	46	1.1	51224	53224	53224U	154000	470000	1200	1800	123	170	145	175	15	125	61	150	140	145	1	2.86	2.76	3.40			
	210	70	74.1	80	2.1	51324	53324	53324U	310000	870000	790	1100	123	205	165	220	22	160	63	174	156	165	2	10.6	10.4	12.4			
	250	102	107.3	118	4	51424	53424	53424U	455000	1340000	580	880	123	245	185	260	32	200	70	198	172	185	3	25.0	24.6	29.2			
130	170	30			1	51126			104000	350000	1300	2000	132	170							154	145		1	1.87				
	190	45	47.9	53	1.5	51226	53226	53226U	203000	620000	1000	1500	133	187	160	195	17	140	67	166	154	160	1.5	4.10	4.03	4.91			
	225	75	80.3	86	2.1	51326	53326	53326U	330000	960000	730	1100	134	220	177	235	26	160	53	187	168	177	2	12.7	12.6	15.2			
	270	110	115.2	128	4	51426	53426	53426U	555000	1750000	540	810	134	265	200	280	38	200	58	214	186	200	3	31.4	30.4	36.7			
140	180	31			1	51128			107000	375000	1300	1900	142	178							164	156		1	2.03				
	200	46	48.6	55	1.5	51228	53228	53228U	205000	650000	1000	1500	143	197	170	210	17	160	87	176	164	170	1.5	4.47	4.40	5.61			
	240	80	84.9	92	2.1	51328	53328	53328U	350000	1050000	680	1000	144	235	190	250	26	180	68	200	180	190	2	15.5	15.3	18.2			
	280	112	117	131	4	51428	53428	53428U	545000	1750000	520	780	144	275	206	290	38	225	83	224	196	206	3	33.9	32.9	39.9			
150	190	31			1	21130			109000	400000	1200	1900	152	188							174	166		1	2.16				
	215	50	53.3	60	1.5	51230	53230	53230U	213000	650000	940	1400	153	212	180	225	20.5	160	79	189	176	180	1.5	5.74	5.60	7.28			
	250	80	83.7	92	2.1	51330	53330	53330U	360000	1130000	670	1000	154	245	200	260	26	200	89.5	210	190	200	2	16.3	16.0	19.1			
	300	120	125.9	140	4	51430	53430	53430U	615000	2010000	480	720	154	295	225	310	41	225	69	240	210	225	3	41.6	40.5	48.5			
160	200	31			1	51132			112000	425000	1200	1800	162	198							184	176		1	2.27				
	225	51	54.7	61	1.5	51232	53232	53232U	223000	720000	900	1300	163	222	190	235	21	160	74	223	202	190	1.5	6.64	6.50	8.29			
	270	87	91.7	100	3	51332	53332	53332U	410000	1340000	610	920	164	265	215	280	29	200	77	226	204	215	2.5	21.0	20.5	24.5			
	320	130	135.3	150	5	51432	53432	53432U	680000	2410000	440	670	164	315	240	330	41.5	250	84	256	224	240	4	51.2	49.7	58.9			
170	215	34			1.1	51134			134000	510000	1100	1700	172	213							197	188		1	3.27				
	240	55	58.7	65	1.5	51234	53234	53234U	261000	835000	840	1200	173	237	200	250	21.5	180	91	212	198	200	1.5	8.13	7.89	9.95			
	280	87	91.3	100	3	51334	53334	53334U	420000	1430000	600	900	174	275	220	290	29	225	105	230	210	220	2.5	22.0	21.3	25.7			
	340	135	141	156	5	51434	53434	53434U	755000	2730000	420	630	174	335	255	350	46	250	74	272	238	255	4	60.1	58.1	69.1			
180	225	34			1.1	51136			135000	525000	1100	1600	183	222							207	198		1	3.37				
	250	56	58.2	66	1.5	51236	53236	53236U	266000	875000	810	1200	183	247	210	260	21.5	200	112	222	208	210	1.5	8.69	8.26	10.5			
	300	95	99.3	109	3	51336	53336	53336U	485000	1700000	550	820	184	295	240	310	32	225	91	252	228	240	2.5	28.2	27.0	32.0			
	360	140	148.3	164	5	51436	53436	53436U	785000	2980000	400	600	184	355	270	370	46.5	280	97	288	252	270	4	69.5	68.8	81.5			



d: 190 ~ 360 mm

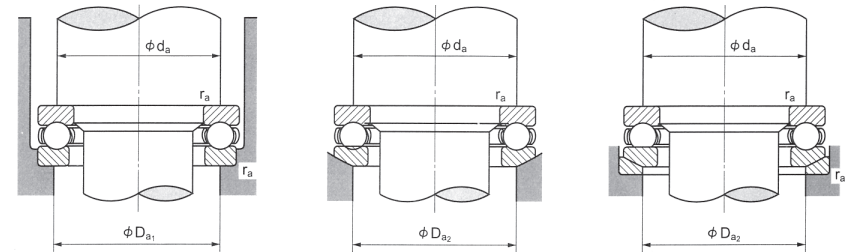
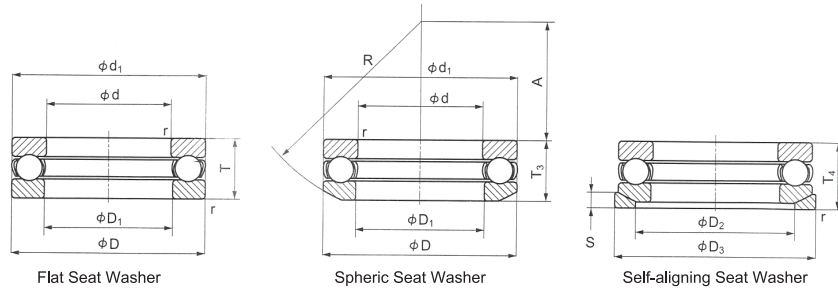

Principal Dimensions (mm)						Bearing Designations			Basic Load Ratings (N)		Limiting Speed (rpm)		Bearing Designations							Abutment and Fillet Dimensions				Weight (kg)		
d	D	T	T ₃	T ₄	r (min)	Flat Seat Washer	Spheric Seat Washer	Self-Aligning Seat Washer	Dynamic Ca	Static Coa	Grease	Oil	D ₁ (min)	d ₁ (max)	D ₂	D ₃	S	R	A	d _a (min)	D _{a1} (max)	D _{a2} (max)	r _a (max)	Flat Seat Washer	Spheric Seat Washer	Self-Aligning Seat Washer
190	240	37			1.1	51138			170000	655000	1000	1500	193	237						220	210		1	3.95		
	270	62	65.7	73	2	51238	53238	53238U	310000	1060000	740	1100	194	267	230	280	23	200	98	238	222	230	2	11.7	11.5	14.0
	320	105	111	121	4	51338	53338	53338U	570000	2100000	500	750	195	315	255	330	33	250	104	268	242	255	3	36.1	35.8	41.9
200	250	37			1.1	51140			172000	675000	1000	1500	203	247						230	220		1	4.14		
	280	62	65.3	74	2	51240	53240	53240U	315000	1110000	720	1000	204	277	240	290	23	225	125	248	232	240	2	12.2	12.0	14.8
	340	110	118.4	130	4	51340	53340	53340U	625000	2380000	470	710	205	335	270	350	38	250	92	284	256	270	3	43.0	43.1	51.0
220	270	37			1.1	51144			177000	740000	970	1400	223	267						250	240		1	4.51		
	300	63	65.6	75	2	51244	53244	53244U	325000	1210000	690	1000	224	297	260	310	25	225	118	268	252	260	2	13.5	13.0	16.2
240	300	45			1.5	51148			228000	935000	830	1200	243	297						276	264		1.5	7.35		
	340	78	81.6	92	2.1	51248	53248	53248U	430000	1730000	570	860	244	335	290	350	30	250	122	300	280	290	2	23.1	22.3	27.4
260	320	45			1.5	51152			232000	990000	800	1200	263	317						296	284		1.5	7.94		
	360	79	82.8	93	2.1	51252	53252	53252U	445000	1880000	550	830	264	355	305	370	30	280	152	320	300	305	2	25.0	24.0	29.7
280	350	53			1.5	51156			315000	1350000	700	1000	283	347						322	308		1.5	12.0		
	380	80	85	94	2.1	51256	53256	53256U	450000	1950000	530	800	284	375	325	390	31	280	143	340	320	325	2	27.0	26.2	32.3
300	380	62			2	51160			370000	1660000	610	920	304	376						348	332		2	17.1		
	420	95	100.5	112	3	51260	53260	53260U	585000	2720000	450	680	304	415	360	430	34	320	164	372	348	360	2.5	42.3	41.7	49.9
320	400	63			2	51164			380000	1760000	590	880	324	396						368	352		2	18.5		
	440	95	100.5	112	3	51264	53264	53264U	595000	2830000	440	660	325	435	380	450	36	320	157	392	368	380	2.5	44.7	43.8	52.7
340	420	64			2	51168			385000	1860000	570	850	344	416						388	372		2	19.9		
	460	96	100.3	113	3	51268	53268	53268U	600000	2940000	430	640	345	455	400	470	36	360	199	412	388	400	2.5	47.6	46.4	56.2
360	440	65			2	51172			395000	1960000	550	820	364	436						408	392		2	20.4		
	500	110	116.7	130	4	51272	53272	53272U	745000	3800000	380	570	365	495	430	510	43	360	172	444	416	430	3	69.0	67.7	81.5



d: 10 ~ 140 mm

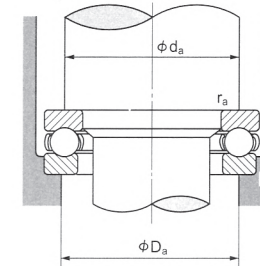
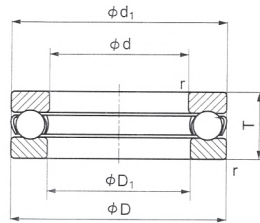

Principal Dimensions (mm)				Bearing Designations	Basic Load Ratings (N)		Limiting Speed (rpm)		Bearing Designations	Abutment and Fillet Dimensions			Weight (kg)		
d	D	T	r (min)		Dynamic C _o	Static C _o	Grease	Oil		D ₁ (min)	d ₁ (max)	d _a (min)		D _a (max)	r _a (max)
10	26	12	0.6	2900	12700	17100	5600	8400		10.2	26	19.6	16.4	0.6	0.035
12	28	12	0.6	2901	13200	19000	5400	8100		12.2	28	21.6	18.4	0.6	0.037
15	31	12	0.6	2902	14300	22800	5100	7700		15.2	31	25	21	0.6	0.041
18	35	12	0.6	2903	14400	24700	4800	7300		18.2	35	28	25	0.6	0.045
20	37	12	0.6	2904	14800	26600	4700	7100		20.2	37	30	27	0.6	0.055
22	42	14	0.6	29/22	18900	34500	4100	6100		22.2	42	34	30	0.6	0.085
25	45	14	0.6	2905	19300	37000	3900	5900		25.2	45	37	33	0.6	0.093
30	50	14	0.6	2906	20200	42000	3700	5600		30.2	50	42	38	0.6	0.107
35	55	16	0.6	2907	29900	62000	3300	5000		35.2	55	47	43	0.6	0.137
40	60	16	0.6	2908	31000	70000	3200	4800		40.2	60	52	48	0.6	0.150
45	68	16	0.6	2909	32500	77500	3000	4500		45.2	68	59	54	0.6	0.199
50	74	18	0.6	2910	38500	94000	2700	4100		50.2	74	64	60	0.6	0.255
55	78	18	0.6	2911	40000	103000	2600	4000		55.2	78	69	64	0.6	0.270
60	82	18	0.6	2912	40500	108000	2600	3900		60.2	82	73	69	0.6	0.275
65	90	20	0.6	2913	47500	129000	2300	3500		65.2	90	80	75	0.6	0.374
70	95	20	0.6	2914	49000	140000	2200	3400		70.2	95	85	80	0.6	0.400
75	100	20	0.6	2915	51000	151000	2200	3300		75.2	100	90	85	0.6	0.425
80	110	22	0.6	2916	57000	171000	2000	3000		80.2	110	98	92	0.6	0.600
85	115	22	0.6	2917	59000	184000	1900	2900		85.2	115	103	97	0.6	0.640
90	120	22	0.6	2918	59500	190000	1900	2900		90.2	120	108	102	0.6	0.670
95	130	25	0.6	2919	75500	236000	1700	2600		95.2	130	116	109	0.6	0.795
100	135	25	0.6	2920	78000	253000	1700	2500		100.2	135	121	114	0.6	0.930
105	140	25	0.6	2921	78500	262000	1600	2500		105.2	140	126	119	0.6	1.02
110	145	25	0.6	2922	78000	262000	1600	2400		110.2	145	131	124	0.6	1.15
115	150	25	0.6	2923	73500	245000	1600	2400		115.2	150	136	129	0.6	1.25
120	160	27	0.6	2924	94000	314000	1500	2200		120.2	160	141	136	0.6	1.35
125	165	27	0.6	2925	85500	298000	1400	2200		125.3	165	149	141	0.6	1.48
140	185	31	0.6	2928	106000	375000	1300	1900		140.3	185	167	158	0.6	2.33



d: 25 ~ 120 mm

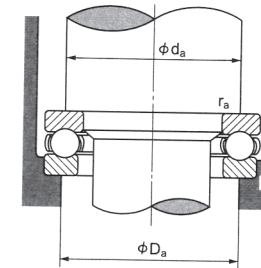
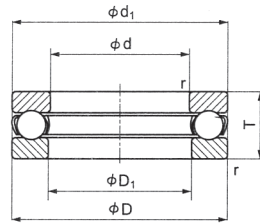

Principal Dimensions (mm)				Bearing Designations	Basic Load Ratings (N)		Limiting Speed (rpm)			Bearing Designations		Abutment and Fillet Dimensions			Weight (kg)
d	D	T	r (min)		Dynamic Ca	Static Coa	Grease	Oil		D ₁ (min)	d ₁ (max)	d _a (min)	D _a (max)	r _a (max)	
25	52	16	1	3905	27100	50500	3400	5200		25.2	52	42	36	1.0	0.147
30	60	19	1	3906	38000	72500	2900	4400		30.2	60	49	43	1.0	0.237
35	68	22	1	3907	50500	99000	2500	3800		35.2	68	56.5	48.5	1.0	0.346
40	76	25	1	3908	61000	119000	2200	3400		40.2	76	63	55	1.0	0.486
45	85	28	1	3909	79500	163000	2000	3000		45.2	85	71	61	1.0	0.684
50	92	31	1	3910	97000	202000	1800	2800		50.2	92	77	67	1.0	0.889
55	100	33	1	3911	110000	240000	1700	2600		55.2	100	83.5	73.5	1.0	1.114
60	106	35	1.5	3912	119000	263000	1600	2400		60.2	106	89	79	1.5	1.293
65	112	36	1.5	3913	128000	287000	1500	2300		65.2	112	95.5	83.5	1.5	1.443
70	120	38	1.5	3914	143000	335000	1400	2200		70.2	120	102	90	1.5	1.767
75	128	41	1.5	3915	159000	365000	1300	2000		75.2	128	108.5	96.5	1.5	2.132
80	136	44	1.5	3916	183000	425000	1200	1900		80.2	136	115	101	1.5	2.606
85	145	47	1.5	3917	207000	490000	1100	1700		85.2	145	122	108	1.5	3.157
90	155	50	1.5	3918	232000	555000	1100	1600		90.2	155	131	115	1.5	3.907
95	165	54	1.5	3919	253000	630000	1000	1500		95.2	165	139	123	1.5	4.810
100	172	57	1.5	3920	250000	630000	980	1400		100.2	172	144	128	1.5	5.454
105	180	60	2.5	3921	257000	670000	930	1400		105.2	180	153	137	2.5	6.354
110	190	63	2.5	3922	293000	785000	880	1300		110.2	190	159	141	2.5	7.333
115	200	66	2.5	3923	315000	870000	840	1200		115.2	200	167.5	147.5	2.5	8.526
120	210	69	2.5	3924	325000	930000	800	1200		120.2	210	178	158	2.5	10.195



d: 9.525 ~ 152.400 mm

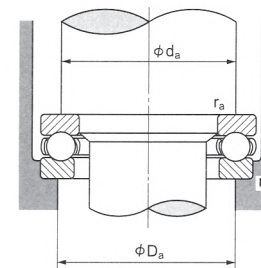
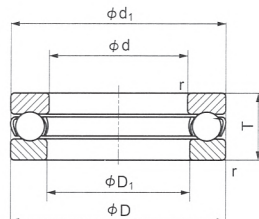

Principal Dimensions (mm)				Bearing Designations	Basic Load Ratings (N)		Limiting Speed (rpm)				Bearing Designations		Abutment and Fillet Dimensions			Weight (kg)
d	D	T	r (min)		Dynamic Ca	Static Coa	Grease	Oil			D ₁ (min)	d ₁ (max)	d _a (min)	D _a (max)	r _a (max)	
9.525	25.400	13.494	0.8	O- 3	11800	15200	5400	8100			9.925	24.606	19.1	15.9	0.8	0.036
12.700	32.544	15.875	0.8	O- 4	18600	25100	4300	6500			13.097	31.750	24.6	20.6	0.8	0.077
15.875	35.719	15.875	0.8	O- 5	19400	28300	4100	6200			16.272	34.925	27.8	23.8	0.8	0.086
19.050	38.894	15.875	0.8	O- 6	21400	34500	4000	6000			19.447	38.100	29	26	0.8	0.095
22.225	42.069	15.875	0.8	O- 7	21900	37500	3800	5800			22.622	41.275	34	30	0.8	0.100
25.400	45.244	15.875	1.6	O- 8	22500	41000	3700	5500			25.797	44.450	37	33	0.8	0.110
28.575	48.419	15.875	1.6	O- 9	24100	47000	3600	5400			28.972	47.625	40	37	0.8	0.128
31.750	53.181	18.256	1.6	O- 10	27900	54500	3200	4800			32.147	52.388	45	40	0.8	0.164
34.925	56.356	18.256	1.6	O- 11	28600	58000	3100	4600			35.322	55.562	48	43	0.8	0.186
38.100	59.531	18.256	1.6	O- 12	30500	66000	3000	4500			38.497	58.738	51	47	1	0.200
41.275	62.706	18.256	1.6	O- 13	26700	63000	2900	4400			41.672	61.912	54	50	1	0.210
44.450	68.262	19.050	1.6	O- 14	32500	77500	2700	4100			44.847	67.469	59	54	1	0.260
47.625	71.438	19.050	1.6	O- 15	37500	89000	2700	4000			48.021	70.644	62	57	1	0.285
50.800	75.406	19.050	2.4	O- 16	38000	94000	2600	3900			51.594	74.613	66	61	1	0.300
53.975	81.756	22.225	2.4	O- 17	49500	118000	2300	3500			54.769	80.962	71	65	1.6	0.405
57.150	84.931	22.225	2.4	O- 18	50500	125000	2300	3400			57.944	84.138	74	68	1.6	0.450
60.325	91.281	25.400	2.4	O- 19	58000	145000	2000	3100			61.119	90.488	79	73	1.6	0.590
63.500	94.456	25.400	2.4	O- 20	59500	152000	2000	3000			64.294	93.662	82	76	1.6	0.610
66.675	97.631	25.400	2.4	O- 21	60500	160000	2000	3000			67.469	96.838	85	79	1.6	0.660
69.850	102.394	25.400	2.4	O- 22	71500	179000	1900	2900			70.644	101.600	89	83	1.6	0.700
73.025	105.569	25.400	2.4	O- 23	75500	199000	1900	2800			73.819	104.775	93	86	1.6	0.730
76.200	111.125	28.575	3.2	O- 24	77000	209000	1700	2600			77.788	109.538	97	90	2	0.900
82.550	122.238	31.750	3.2	O- 26	97500	252000	1600	2400			84.138	120.650	106	98	2	1.30
88.900	128.588	31.750	3.2	O- 28	99000	266000	1500	2300			90.488	127.000	113	105	2	1.32
95.250	134.938	31.750	3.2	O- 30	98500	289000	1500	2200			96.838	133.350	119	111	2	1.36
101.600	147.638	34.925	3.2	O- 32	113000	310000	1300	2000			103.188	146.050	129	120	2	1.88
114.300	166.688	44.450	4.8	O- 36	157000	435000	1100	1700			115.888	165.100	146	135	3	3.18
127.000	185.738	50.800	4.8	O- 40	193000	545000	1000	1500			128.588	184.150	162	150	3	4.54
139.700	204.788	55.562	4.8	O- 44	248000	715000	910	1300			141.288	203.200	179	166	3	5.90
152.400	220.662	60.325	4.8	O- 48	269000	805000	830	1200			153.988	219.075	193	180	3	7.25



d: 15 ~ 80 mm

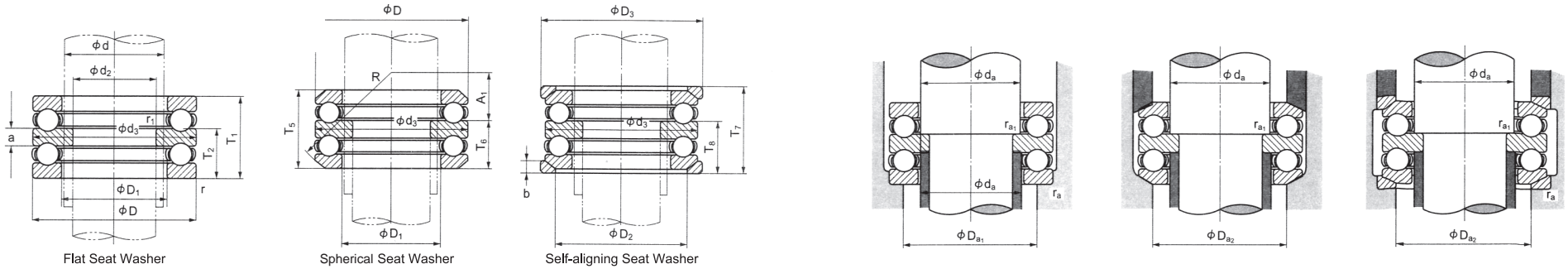

Principal Dimensions (mm)								Bearing Designations			Basic Load Ratings (N)		Limiting Speed (rpm)		Bearing Designations											Abutment and Fillet Dimensions			Weight (kg)					
d	d ₂	D	T ₁	T ₅	T ₇	r (min)	r ₁ (min)	Flat Seat Washer	Spherical Seat Washer	Self-Aligning Seat Washer	Dynamic C _a	Static C _{0a}	Grease	Oil	d ₃ (max)	D ₁ (min)	D ₂	D ₃	T ₂	T ₆	T ₈	T ₉	a	b	A ₁	R	d _a (min)	D _{a1} (max)	D _{a2} (max)	r _a (max)	r _{a1} (max)	Flat Seat Washer	Spherical Seat Washer	Self-Aligning Seat Washer
15	10	32	22	24.6	28	0.6	0.3	52202	54202	54202U	16600	24800	5100	7600	32	17	24	35	13.5	14.8	16.5	5	4	10.5	28	15	22	24	0.6	0.3	0.085	0.090	0.116	
20	15	40	26	27.4	32	0.6	0.3	52204	54204	54204U	22200	37500	4200	6300	40	22	30	42	16	16.7	19	6	5	16	36	20	28	30	0.6	0.3	0.150	0.147	0.189	
25	20	47	28	31.4	36	0.6	0.3	52205	54205	54205U	27800	50500	3700	5600	47	27	36	50	17.5	19.2	21.5	7	5.5	16.5	40	25	34	36	0.6	0.3	0.230	0.241	0.305	
25	20	52	34	37.6	42	1	0.3	52305	54305	54305U	35500	61500	3200	4900	52	27	38	55	21	22.8	25	8	6	18	45	25	36	38	1	0.3	0.330	0.340	0.431	
25	15	60	45	49.8	55	1	0.6	52405	54405	54405U	55500	89500	2600	3900	60	27	42	62	28	30.4	33	11	8	15	50	25	39	42	1	0.6	0.630	3.650	0.796	
30	25	52	29	32.6	37	0.6	0.3	52206	54206	54206U	29300	58000	3400	5200	52	32	42	55	18	19.8	22	7	5.5	20	45	30	39	42	0.6	0.3	0.272	0.291	0.356	
30	25	60	38	41.2	46	1	0.3	52306	54306	54306U	42500	78500	2800	4200	60	32	45	62	23.5	25.1	27.5	9	7	19.5	50	30	42	45	1	0.3	0.490	0.495	0.607	
30	20	70	52	56.2	62	1	0.6	52406	54406	54406U	72500	126000	2200	3300	70	32	50	75	32	34.1	37	12	9	16	56	30	46	50	1	0.6	1.00	1.00	1.26	
35	30	62	34	37.8	42	1	0.3	52207	54207	54207U	39000	78000	2900	4400	62	37	48	65	21	22.9	25	8	7	21	50	35	46	48	1	0.3	0.420	0.431	0.550	
35	30	68	44	47.2	52	1	0.3	52307	54307	54307U	55500	105000	2400	3700	68	37	52	72	27	28.6	31	10	7.5	21	56	35	48	52	1	0.3	0.710	0.711	0.881	
35	25	80	59	63	69	1.1	0.6	52407	54407	54407U	87000	155000	1900	2900	80	37	58	85	36.5	38.5	41.5	14	10	18.5	64	35	53	58	1	0.6	1.44	1.43	1.78	
40	30	68	36	38.6	44	1	0.6	52208	54208	54208U	47000	98500	2700	4100	68	42	55	72	22.5	23.8	26.5	9	7	25	56	40	51	55	1	0.6	0.540	0.542	0.686	
40	30	78	49	54	59	1	0.6	52308	54308	54308U	69000	135000	2200	3300	78	42	60	82	30.5	33	35.5	12	8.5	23.5	64	40	55	60	1	0.6	1.06	1.10	1.33	
40	30	90	65	69.4	77	1.1	0.6	52408	54408	54408U	112000	205000	1700	2600	90	42	65	95	40	42.2	46	15	12	22	72	40	60	65	1	0.6	2.03	2.00	2.52	
45	35	73	37	39.6	45	1	0.6	52209	54209	54209U	47500	105000	2600	3900	73	47	60	78	23	24.3	27	9	7.5	23	56	45	56	60	1	0.6	0.620	0.617	0.796	
45	35	85	52	56.2	62	1	0.6	52309	54309	54309U	80000	163000	2000	3000	85	47	65	90	32	34.1	37	12	10	21	64	45	61	65	1	0.6	1.29	1.28	1.63	
45	35	100	72	78.8	86	1.1	0.6	52409	54409	54409U	129000	243000	1600	2400	100	47	72	105	44.5	47.9	51.5	17	12.5	23.5	80	45	67	72	1	0.6	2.71	2.76	3.40	
50	40	78	39	42	47	1	0.6	52210	54210	54210U	48500	112000	2400	3600	78	52	62	82	24	25.5	28	9	7.5	30.5	64	50	61	62	1	0.6	0.71	0.697	0.899	
50	40	95	58	64.6	70	1.1	0.6	52310	54310	54310U	96500	202000	1800	2700	95	52	72	100	36	39.3	42	14	11	23	72	50	68	72	1	0.6	1.86	1.92	2.37	
50	40	110	78	83.2	92	1.5	0.6	52410	54410	54410U	148000	283000	1400	2100	110	52	80	115	48	50.6	55	18	14	30	90	50	74	80	1.5	0.6	3.56	3.52	4.36	
55	45	90	45	49.6	55	1	0.6	52211	54211	54211U	69500	159000	2100	3100	90	57	72	95	27.5	29.8	32.5	10	9	32.5	72	55	69	72	1	0.6	1.12	1.14	1.54	
55	45	105	64	72.6	78	1.1	0.6	52311	54311	54311U	120000	246000	1600	2400	105	57	80	110	39.5	43.8	46.5	15	11.5	25.5	80	55	75	80	1	0.6	2.51	2.65	3.22	
55	45	120	87	92	101	1.5	0.6	52411	54411	54411U	178000	360000	1300	1900	120	57	88	125	53.5	56	60.5	20	15.5	22.5	90	55	81	88	1.5	0.6	4.70	4.55	5.64	
60	50	95	46	50	56	1	0.6	52212	54212	54212U	73500	179000	2000	3000	95	62	78	100	28	30	33	10	9	30.5	72	60	74	78	1	0.6	1.25	1.26	1.59	
60	50	110	64	70.6	78	1.1	0.6	52312	54312	54312U	123000	267000	1600	2400	110	62	85	115	39.5	42.8	46.5	15	11.5	36.5	90	60	80	85	1	0.6	2.68	2.76	3.39	
60	50	130	93	99	107	1.5	0.6	52412	54412	54412U	213000	435000	1200	1800	130	62	95	135	57	60	64	21	16	28	100	60	88	95	1.5	0.6	6.33	6.20	7.45	
65	55	100	47	50.4	57	1	0.6	52213	54213	54213U	75000	189000	1900	2800	100	67	82	105	28.5	30.2	33.5	10	9	38.5	80	65	79	82	1	0.6	1.36	1.35	1.72	
65	55	115	65	71.8	79	1.1	0.6	52313	54313	54313U	127000	287000	1500	2300	115	67	90	120	40	43.4	47	15	12.5	34.5	90	65	85	90	1	0.6	2.90	2.98	3.67	
65	50	140	101	109.4	119	2	1	52413	54413	54413U	231000	495000	1100	1600	140	68	100	145	62	66.2	71	23	17.5	34	112	65	95	100	2	1	8.03	8.01	9.67	
70	55	105	47	50.6	57	1	1	52214	54214	54214U	76000	199000	1800	2800	105	72	88	110	28.5	30.3	33.5	10	9	36.5	80	70	84	88	1	1	1.48	1.48	1.86	
70	55	125	72	80.4	88	1.1	1	52314	54314	54314U	148000	340000	1400	2100	125	72	98	130	44	48.2	52	16	13	39	100	70	92	98	1	1	3.90	4.08	4.92	
70	55	150	107	114.2	125	2	1	52414	54414	54414U	250000	555000	1000	1500	150	73	110	155	65.5	69.1	74.5	24	19.5	28.5	112	70	102	110	2	1	9.71	9.50	11.5	
75	60	110	47	49.6	57	1	1	52215	54215	54215U	77500	209000	1800	2700	110	77	92	115	28.5	29.8	33.5	10	9.5	47.5	90	75	89	92	1	1	1.57	1.53	1.96	
75	60	135	79	87.2	95	1.5	1	52315	54315	54315U	170000	395000	1200	1900	135	77	105	140	48.5	52.6	56.5	18	15	32.5	100	75	99	105	1.5	1	4.83	4.93	6.04	
75	60	160	115	123	135	2	1	52415	54415	54415U	252000	560000	950	1400	160	78	115	165	70.5	74.5	80.5	26	21	36.5	125	75	109	115	2	1	11.8	11.6	14.1	
80	65	115	48	51	58	1	1	52216	54216	54216U	78500	219000	1700	2600	115	82	98	120	29	30.5	34	10	10	45	90	80	94	98	1	1	1.69	1.67	2.11	
80	65	140	79	86.2	95	1.5	1	52316	54316	54316U	176000	425000	1200	1800	140	82	110	145	48.5	52.1	56.5	18	15	45.5	112	80	104	110	1.5	1	5.06	5.14	6.29	
80	65	170	120	128.4	140	2.1	1	52416	54416	54416U	270000	620000	900	1300	170	83	125	175	73.5	77.7	83.5	27	22	30.5	125	80	116	125	2	1	14.0	13.7	16.5	



d: 85 ~ 220 mm

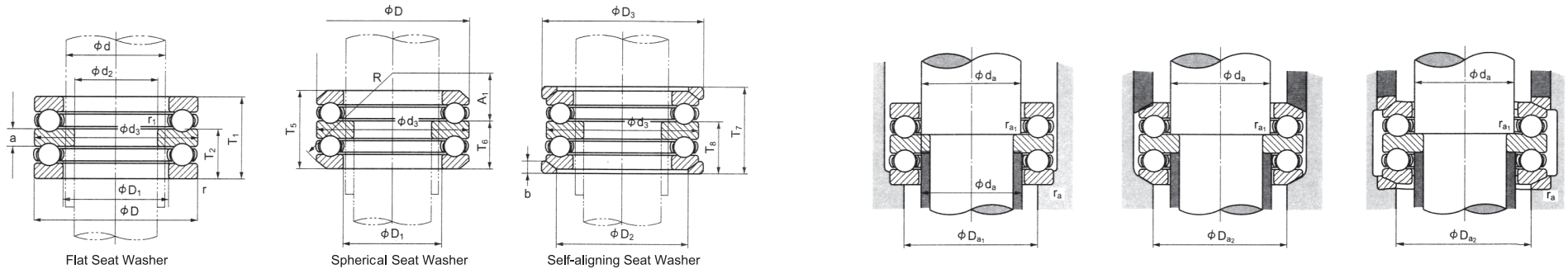

Principal Dimensions (mm)								Bearing Designations			Basic Load Ratings (N)		Limiting Speed (rpm)		Bearing Designations											Abutment and Fillet Dimensions			Weight (kg)				
d	d ₂	D	T ₁	T ₅	T ₇	r (min)	r ₁ (min)	Flat Seat Washer	Spherical Seat Washer	Self-Aligning Seat Washer	Dynamic C _a	Static C _{0a}	Grease	Oil	d ₃ (max)	D ₁ (min)	D ₂	D ₃	T ₂	T ₆	T ₈	a	b	A ₁	R	d _a (min)	D _{a1} (max)	D _{a2} (max)	r _a (max)	ra1 (max)	Flat Seat Washer	Spherical Seat Washer	Self-Aligning Seat Washer
85	70	125	55	59.2	67	1	1	52217	54217	54217U	95500	264000	1600	2400	125	88	105	130	33.5	35.6	39.5	12	11	49.5	100	85	101	105	1	1	2.34	2.34	2.93
	70	150	87	95.2	105	1.5	1	52317	54317	54317U	206000	490000	1100	1700	150	88	115	155	53	57.1	62	19	17.5	39	112	85	111	115	1.5	1	6.43	6.41	8.05
	65	180	128	138	150	2.1	1.1	52417	54417	54417U	288000	685000	850	1200	179.5	88	130	185	78.5	83.5	89.5	29	23	40.5	140	85	123	130	2	1	17.5	17.3	20.7
90	75	135	62	69	76	1.1	1	52218	54218	54218U	116000	325000	1400	2100	135	93	110	140	38	41.5	45	14	13.5	42	100	90	108	110	1	1	3.22	3.25	4.12
	75	155	88	97.2	106	1.5	1	52318	54318	54318U	213000	525000	1100	1600	155	93	120	160	53.5	58.1	62.5	19	18	36.5	112	90	116	120	1.5	1	6.60	6.62	8.33
	70	190	135	143.4	157	2.1	1.1	52418	54418	54418U	305000	750000	790	1100	189.5	93	140	195	82.5	86.7	93.5	30	25.5	34.5	140	90	130	140	2	1	19.6	19.1	23.0
100	85	150	67	72.8	81	1.1	1	52220	54220	54220U	146000	410000	1300	1900	150	103	125	155	41	43.9	48	15	14	49	112	100	120	125	1	1	4.29	4.29	5.32
	85	170	97	105.4	115	1.5	1	52320	54320	54320U	236000	595000	1000	1500	170	103	135	175	59	63.2	68	21	18	42	125	100	128	135	1.5	1	8.90	8.92	10.8
	80	210	150	160	176	3	1.1	52420	54420	54420U	345000	895000	710	1000	209.5	103	155	220	91.5	96.5	104.5	33	27	43.5	160	100	144	155	2.5	1	26.6	26.2	32.0
110	95	160	67	71.4	81	1.1	1	52222	54222	54222U	153000	450000	1200	1900	160	113	135	165	41	43.2	48	15	14	62	125	110	130	135	1	1	4.68	4.60	5.74
	95	190	110	118.4	128	2	1	52322	54322	54322U	268000	705000	880	1300	189.5	113	150	195	67	71.2	76	24	20.5	47	140	110	142	150	2	1	13.8	13.7	16.3
	90	230	166			3	1.1	52422			435000	1240000	640	960	229	113			101.5			37			110	158		2.5	1	34.9			
120	100	170	68	71.6	82	1.1	1.1	52224	54224	54224U	152000	470000	1200	1800	170	123	145	175	41.5	43.3	48.5	15	15	58.5	125	120	140	145	1	1	5.24	5.04	6.36
	100	210	123	131.2	143	2.1	1.1	52324	54324	54324U	267000	870000	790	1100	209.5	123	165	220	75	79.1	85	27	22	58	160	120	156	165	2	1	17.2	16.9	21.0
	95	250	177			4	1.5	52424			455000	1340000	580	880	249	123			105.5			40			120	172		3	1.5	44.2			
130	110	190	80	85.8	96	1.5	1.1	52226	24226	24226U	203000	620000	1000	1500	189.5	133	160	195	49	51.9	57	18	17	63	140	130	154	160	1.5	1	7.72	7.58	9.43
	110	225	130			21	1.1	52326			330000	960000	730	100	224	134			80			30			130	168		2	1	22.1			
	100	270	192			4	2	52426			555000	1750000	540	810	269	134			117			42			130	186		3	2	56.5			
140	120	200	81	86.2	99	1.5	1.1	52228	54228	54228U	205000	650000	1000	1500	199.5	143	170	210	49.5	52.1	58.5	18	17	83.5	160	140	164	170	1.5	1	8.93	8.79	11.3
	120	240	140			2.1	1.1	52328			350000	1050000	680	1000	239	144			85.5			31			140	180		2	1	27.8			
	110	280	196			4	2	52428			545000	1750000	520	780	279	144			120			44			140	196		3	2	60.6			
150	130	215	89	95.6	109	1.5	1.1	52230	54230	54230U	213000	650000	940	1400	214.5	153	180	225	54.5	57.8	64.5	20	20.5	74.5	160	150	176	180	1.5	1	10.6	10.3	13.8
	130	250	140			2.1	1.1	5330			360000	1130000	670	1000	249	154			85.5			31			150	190		2	1	29.2			
	120	300	209			4	2	52430			615000	2010000	480	720	299	153			127.5			46			150	210		3	2	73.9			
160	140	225	90	97.4	110	1.5	1.1	52232	54232	54232U	223000	720000	900	1300	224.5	163	190	235	55	58.7	65	20	21	70	160	160	186	190	1.5	1	12.2	11.9	15.6
	140	270	153			3	1.1	52334			410000	1340000	610	920	269	164			93			33			160	204		2.5	1	37.7			
	130	320	226			5	2	52432			680000	2410000	440	670	319	164			138			50			160	224		4	2	90.3			
170	150	240	97	104.4	117	1.5	1.1	52234	54234	54234U	261000	835000	840	1200	239.5	173	200	250	59	62.7	69	21	21.5	87	180	170	198	200	1.5	1	15.2	14.7	19.1
	150	280	153			3	1.1	52334			420000	1430000	600	900	279	174			93			33			170	214		2.5	1	39.8			
	135	340	236			5	2.1	52434			755000	2730000	420	630	339	174			143			50			170	238		4	2	108			
180	150	250	98	102.5	118	1.5	2	52236	54236	54236U	266000	875000	810	1200	249	183	210	260	59.5	61.7	69.5	21	21.5	108.5	200	180	208	210	1.5	2	16.0	15.2	19.9
	150	300	165			3	2	52336			485000	1700000	550	820	299	184			101			37			180	228		2.5	2	50.9			
	140	360	245			5	3	52436			785000	2980000	400	600	359	184			148.5			52			180	252		4	2.5	126			
190	160	270	109	116.4	131	2	2	52238	54238	54238U	310000	1060000	740	1100	269	194	230	280	66.5	70.2	77.5	24	23	93.5	200	190	222	230	2	2	21.6	21.2	26.5
	160	320	183			4	2	52338			570000	2100000	500	750	319	195			111.5			40			190	242		3	2	64.9			
200	170	280	109	115.6	133	2	2	52240	54240	54240U	315000	1110000	720	1000	279	204	240	290	66.5	69.8	78.5	24	23	120.5	225	200	232	240	2	2	22.7	22.3	28.0
	170	340	192			4	2	52340			625000	2380000	470	710	339	205			117			42			200	256		3	2	77.8			
220	190	300	110	115.2	134	2	2	52244	54244	54244U	325000	1210000	690	1000	299	224	260	310	67	69.6	79	24	25	114	225	220	252	260	2	2	23.9	22.9	29.6

